

27 596
27 725

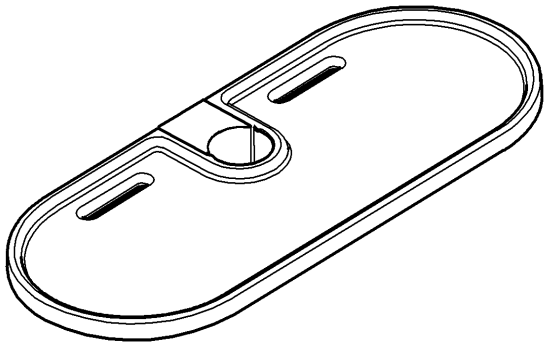

1.

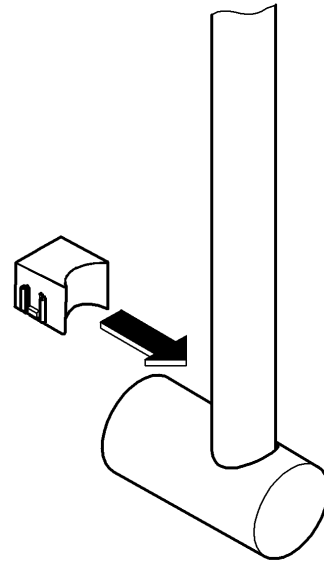

2.

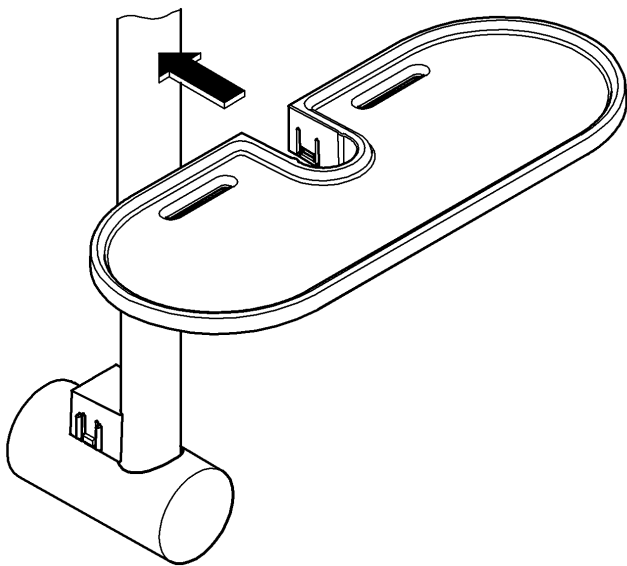

3.

