



Nous vous recommandons de lire intégralement la notice avant de commencer votre installation.

We recommend that you read all the instructions carefully before starting to install your shower.

Wij raden u aan de montagehandleiding aandachtig te lezen vóór u met de plaatsing begint.

Le aconsejamos que lea las instrucciones completamente antes de empezar la instalación.

Wir empfehlen Ihnen, die Montageanweisung vor Beginn der Montage vollständig zu lesen.

Recomendamos que leia totalmente o folheto informativo antes de iniciar a instalação.

Leggere le istruzioni nella loro integralità prima di procedere all'installazione.

Рекомендуем внимательно прочесть инструкцию по сборке перед началом работ.

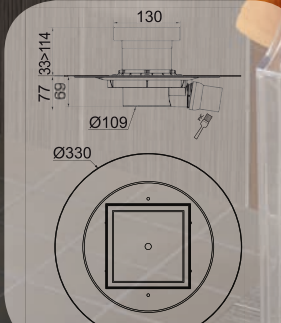
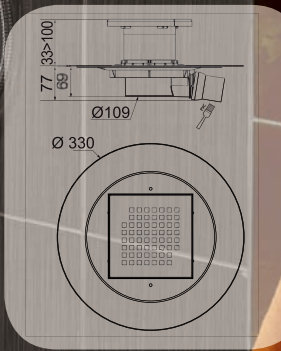

01/2010 - 213738

- 1 Mortier/Mortar/Mortel/Mortero/Mörtel/Cimento/Malta/Строительный раствор
- 2 Colle PVC/PVC adhesive/PVC-lijm/Cola de PVC/PVC-Kleber/Cola de PVC/Cola PVC/клей ПВХ
- 3 Bande de masquage/masking tape/maskeertape/cinta de enmascarar/Abdeckband/fita adesiva de mascarar/nastro di mascheratura/маскировочная лента

not included

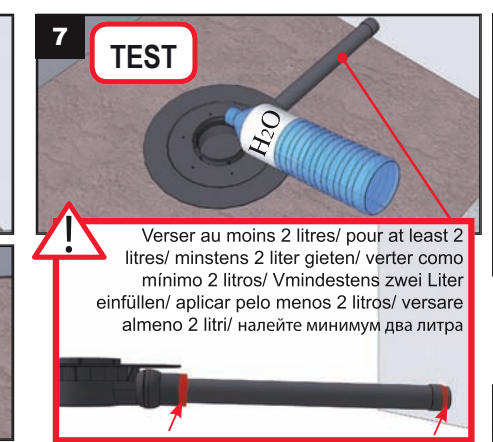
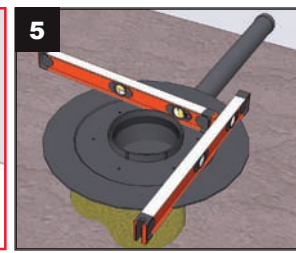
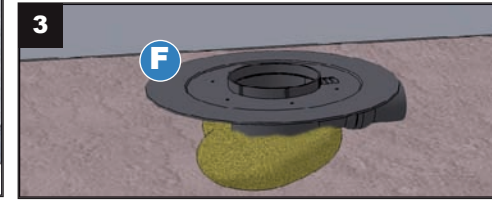
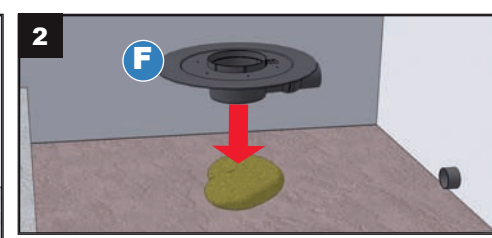
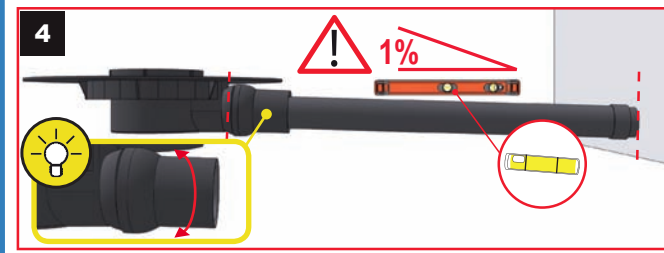
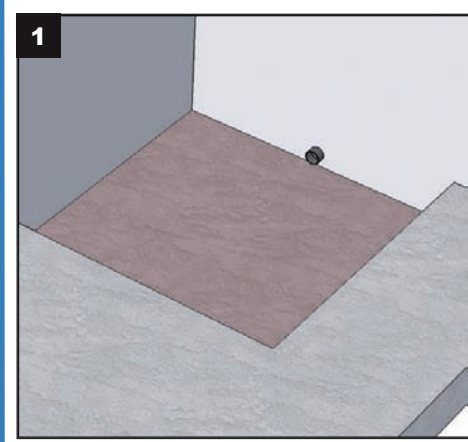
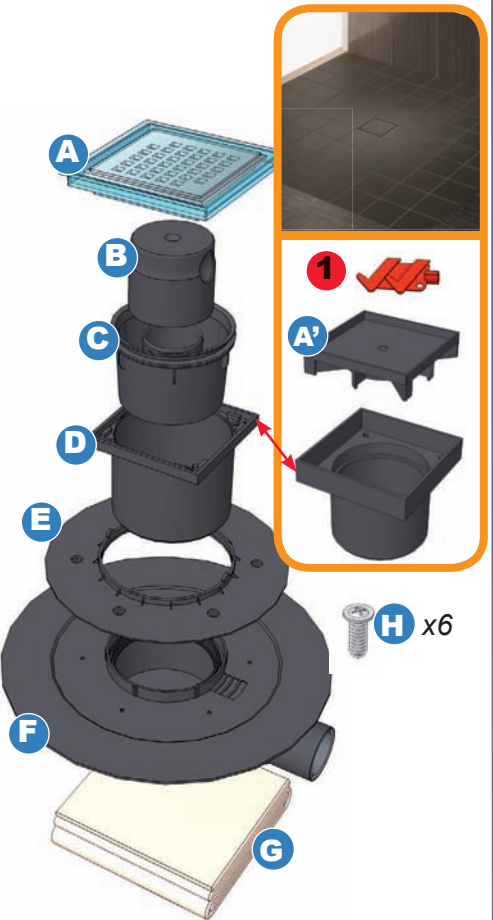

Verser au moins 2 litres/ pour at least 2 litres/ minstens 2 liter gieten/ verter como mínimo 2 litros/ Vmindstens zwei Liter einfüllen/ aplicar pelo menos 2 litros/ versare almeno 2 litri/ налейте минимум два литра

