



QUBIKA



MADE IN ITALY





CARATTERISTICHE TECNICHE:
TECHNICAL CHARACTERISTICS:

La serie è dotata di cartuccia a dischi ceramici, Ø 35 mm, prodotta da S.T.S.R. – Studio Tecnico Sviluppo e Ricerche - www.stsr.it

The series is equipped with ceramic cartridge, Ø 35 mm, produced by S.T.S.R. - Research Development Technical Office - www.stsr.it

Il design di Qubika ha un carattere elegante ed una bellezza immediata.

La base quadrata viene armonicamente intersecata dalle bocche rettangolari di spessore minimo. Ogni singolo componente si lega al precedente in un gioco di angoli vivi che scolpiscono l'oggetto e ne delineano le caratteristiche di essenzialità

e forte impatto estetico. Una serie dalla modernità spiccata e minimale.

Il design della serie è stato ideato dal Gruppo di Ricerca e Sviluppo di Remer Rubinetterie ed ingegnerizzata e prodotta nei nostri stabilimenti produttivi situati in provincia di Milano.

QUBIKA



SIMBOLOGIE:
SYMBOLOLOGY:

- | | | | | | | | |
|---|---|---|---|---|---|---|---|
|  |  |  |  |  |  |  |  |
| Con scarico con Troppo Pieno
With waste with Overflow | Senza scarico
Without waste | Con Click-Clack
With Click-Clack | Con Click-Clack con Troppo Pieno
With Click-Clack with Overflow | Proporzioe perfetta.
The right proportion. | Con Kit Doccia e flessibile
lungo: 120, 150 o 200 cm
With Shower Kit and flexible
long: 120, 150, 200 cm | Con getto a cascata.
With waterfall jet. | Con multigetto.
With multi jet. |
|  |  |  |  |  |  | | |
| Doccetta Anticalcare
Anti-limestone Hand Shower | Soffione Anticalcare ed Autopulente
Anti-limestone and Self-cleaning Shower Head | Getti Anticalcare
Anti-limestone Jets | Corpo girevole
Swivable body. | Canna girevole
Movable spout. | Canna alta girevole
High movable spout. | | |

The design of Qubika has an elegant character and an immediate beauty.

The square base is harmonically intersected by the rectangular spouts of minimum thickness. Each single component is in harmony with the previous one in a game of sharp angles sculpting the object and delineating the characteristics

of simplicity and strong visual impact. A series of high and minimal modernity.

The design of this line has been created by the Research and Development Group of Remer Rubinetterie and ingegnerized and produced in Remer production facilities located in Milan province.





QUBIKA  **PERFECT
TUNE**



Lavabi Washbasins



Q 10

Miscelatore monocomando lavabo.
Single-lever basin mixer.



Q 11

Miscelatore monocomando lavabo.
Single-lever basin mixer.

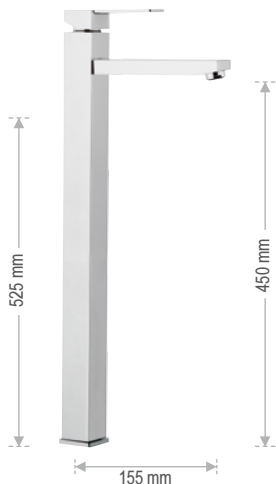

Q 10 LXXL

Miscelatore monocomando lavabo extra alto LXXL.
Single-lever basin mixer LXXL high neck with click-clack waste with overflow.



Q 11 LXXL

Miscelatore monocomando lavabo extra alto LXXL.
Single-lever basin mixer LXXL high neck.

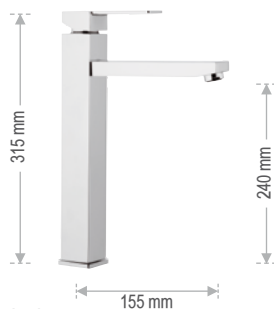

Q 10 L

Miscelatore monocomando lavabo alto L.
Single-lever basin mixer L high neck.



Q 10 LB

Miscelatore monocomando lavabo alto L.
Single-lever basin mixer L high neck.



Q 11 L

Miscelatore monocomando lavabo alto L.
Single-lever basin mixer L high neck.

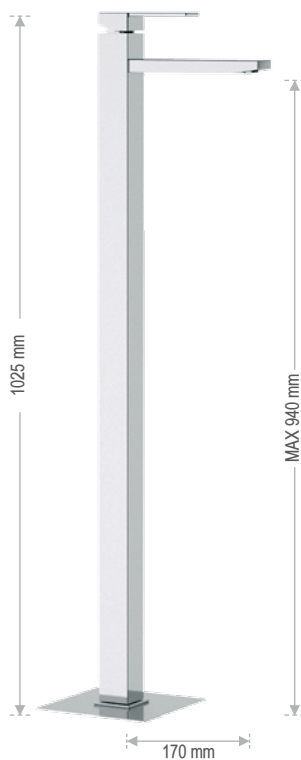

Q 10 LXL

Miscelatore monocomando lavabo extra alto XL.
Single-lever basin mixer extra high XL neck.



Q 11 LXL

Miscelatore monocomando lavabo extra alto XL.
Single-lever basin mixer extra high XL neck.



Q 18

Miscelatore monocomando lavabo da pavimento.
Single-lever basin mixer floor mounting.



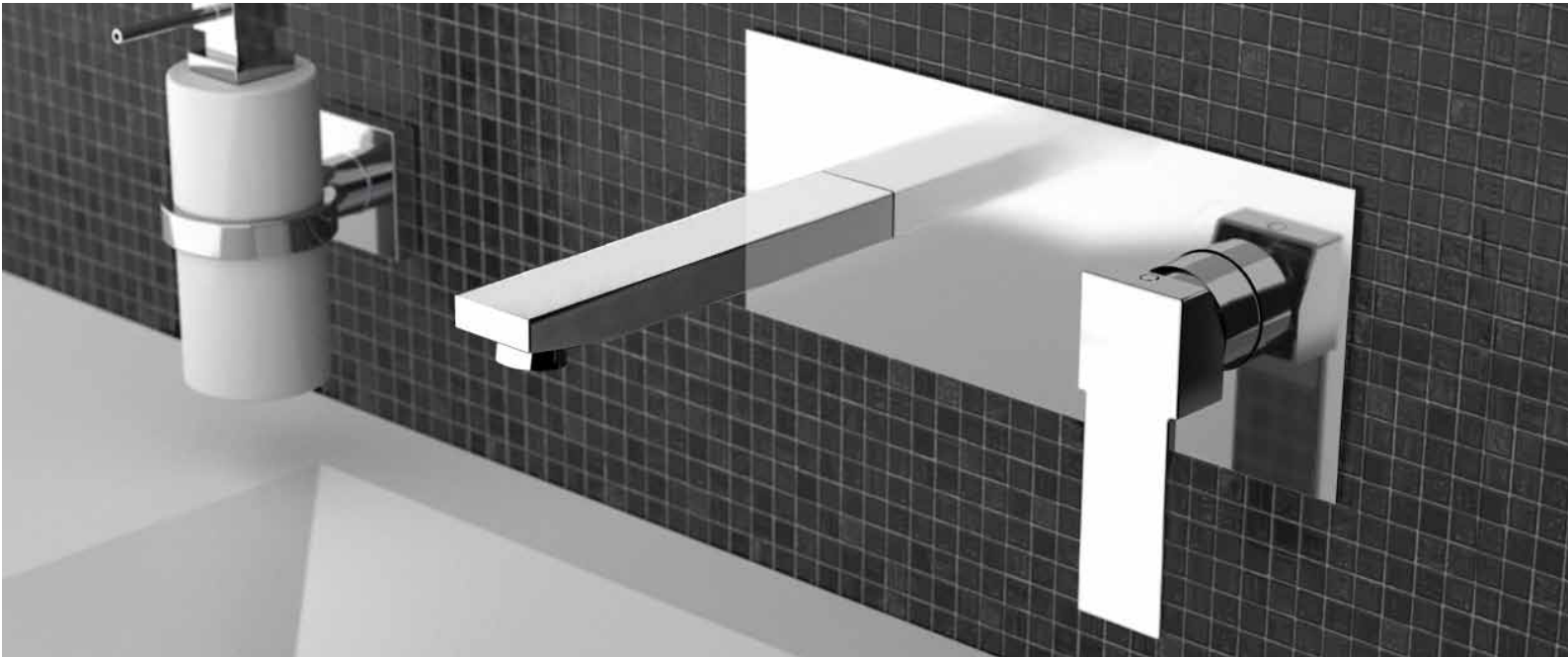

Q 10G

Miscelatore monocomando lavabo, con canna corta a "U".

Single-lever one-hole sink mixer, with short "U" spout.

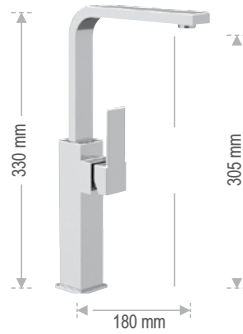

Q 10G L

Miscelatore monocomando lavabo alto L, con canna corta a "U".

L high single-lever one-hole sink mixer, with short "U" spout.

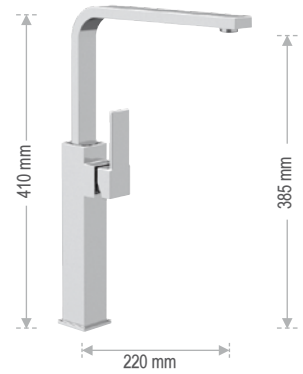

Q 10G LXL

Miscelatore monocomando lavabo alto XL, con canna lunga a "U".

XL high single-lever one-hole sink mixer, with long "U" spout.



Q 15

Miscelatore monocomando a incasso per lavabo, con piastra rettangolare in ottone cromato e bocca qubika lunghezza cm 18.

Single lever built-it basin mixer, with rectangular wall flange in chrome plated brass and qubika spout length cm 18.

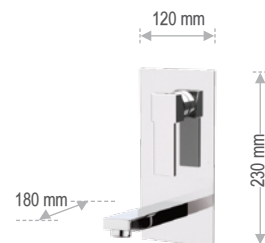

Q 14

Miscelatore monocomando a incasso per lavabo, con piastra verticale rettangolare in ottone cromato e bocca qubika lunghezza cm 18.

Single lever built-it basin mixer, with vertical rectangular wall flange in chrome plated brass and qubika spout length cm 18.



Bidet Bidet



Q 20
Miscelatore monocomando per bidet, con aeratore direzionabile, tettuccio di protezione.
Single-lever bidet mixer with adjustable aerator, covered and shielded.

 **PATENTED**

Q 21
Miscelatore monocomando per bidet, con aeratore direzionabile, tettuccio di protezione.
Single-lever bidet mixer with adjustable aerator, covered and shielded.

 **PATENTED**



Q 23
Miscelatore monocomando per bidet, con doccia.
Single-lever bidet mixer with shower.



Q 60
Miscelatore incasso per shut-off comprensivo di: doccia shut-off ns art 332 OS, supporto doccia-presa acqua su piastra in ottone cromato e flessibile doccia cm 120.

Built-in shut-off mixer set including: shut-off art 332 OS, shower holder-water punch on flange, all in c.p. brass and shower flexible cm 120.

120 cm



Q 63
Miscelatore incasso per shut-off.
Built-in shut-off mixer.

Bocche Spouts

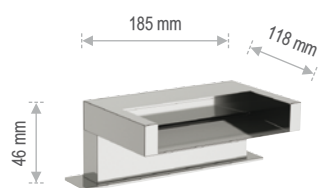

91 ZCA

Bocca bordo vasca getto a cascata.
Spout for deck bath/shower with waterfall jet.

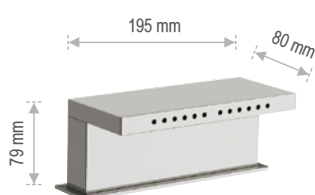

91 ZCF

Bocca bordo vasca con effetto multigetto.
Spout for deck bath/shower with multijets effect.

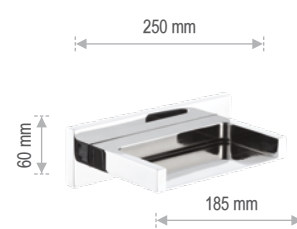

91 ZC

Bocca incasso a cascata, serie ZC.
Built-in spout ZC series, with waterfall effect.



91 Q

Bocca incasso serie Q, cm 18.
Built-in spout Q serie, cm 18.



91 QD

Bocca incasso serie Q, con deviatore integrato, cm 18.
Built-in spout Q serie, with diverter, cm 18.



91 Q2

Bocca incasso cm 18.
Built-in spout cm 18.



Vasca Bath Mixer



Q 02
Miscelatore monocomando per vasca, esterno, con doccia duplex.
Single-lever external bath mixer, with duplex shower.



Q 03
Miscelatore monoforo lavabo/vasca, con deviatore integrato e kit doccia.
Single lever one-hole sink/bath mixer with diverter and shower set.



Q 04
Miscelatore monocomando per vasca da incasso, su piastra rettangolare, con bocca lunga cm 18 con deviatore e kit doccia integrato.
Single-lever bath mixer, with rectangular wall flange, spout long 18cm with diverter and integrated shower kit



Q 05
Miscelatore monocomando per vasca, esterno, senza set doccia.
Single-lever bath mixer, without shower set.

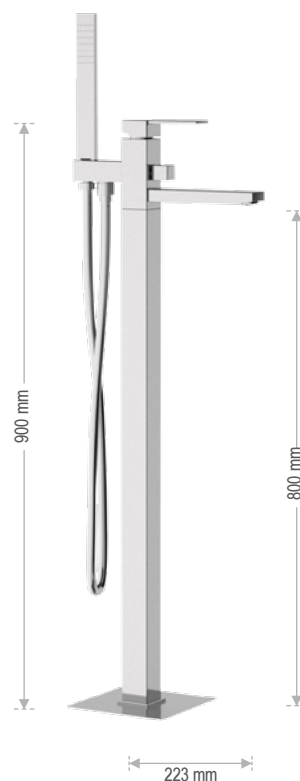

Q 08
Miscelatore vasca da pavimento, con deviatore e kit doccia.
Single-lever bath mixer floor mounting, with diverter and shower kit.





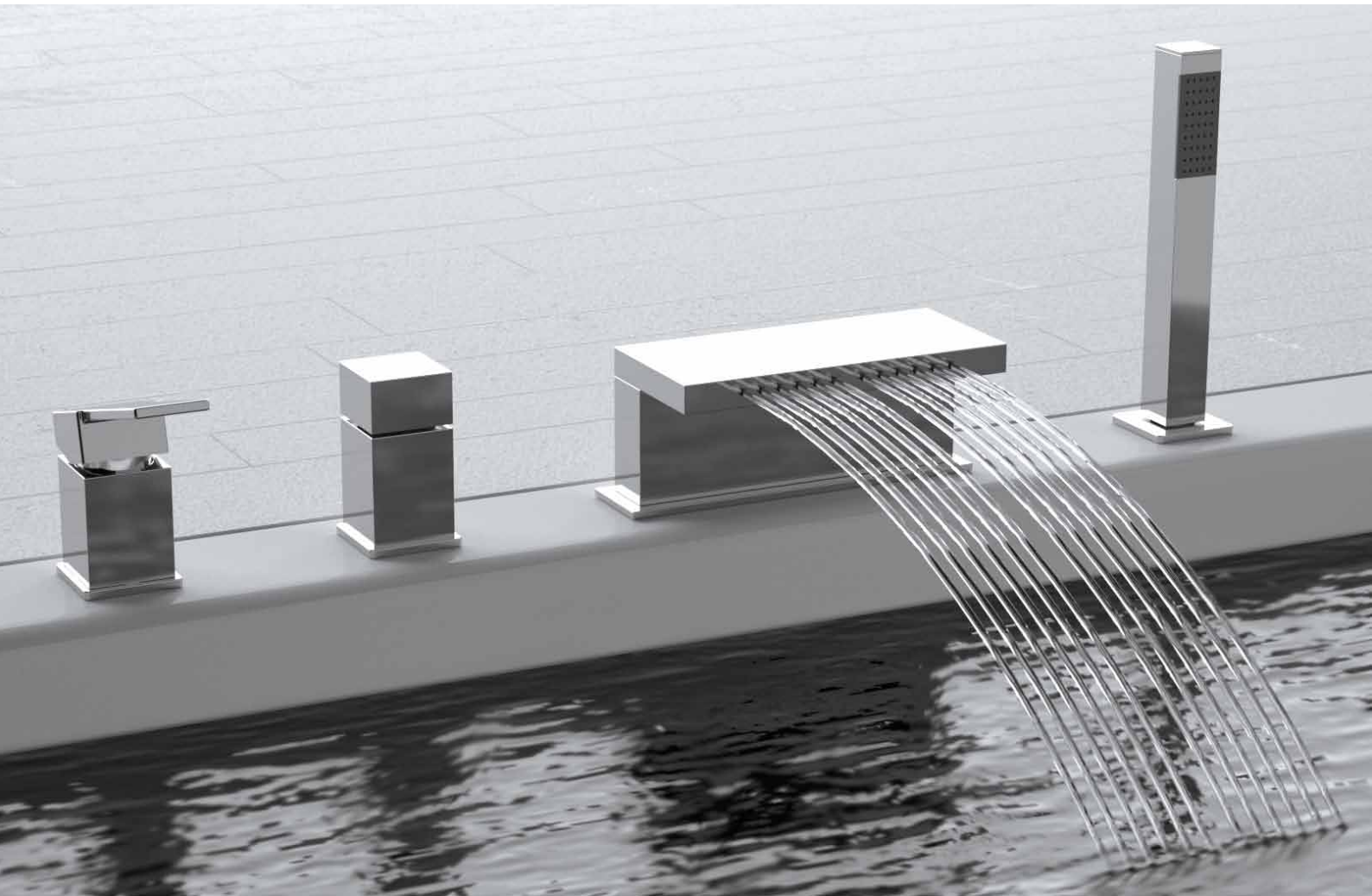

Q 07

Miscelatore monocomando bordo vasca serie Qubika con bocca quadra, deviatore integrato a molla e doccetta quadrata estraibile in ottone cromato.

Single-lever deck bath/shower mixer Qubica series, with squared spout, spring diverter, and squared chrome plated brass pull-out handshower.

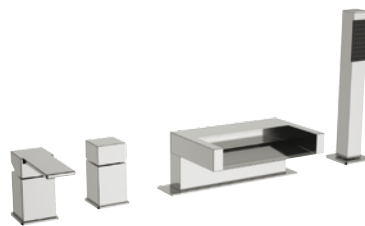

QC 06

Miscelatore monocomando bordo vasca con deviatore, bocca cascata e doccetta in ottone cromato

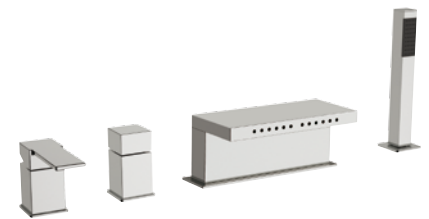

Q 06

Miscelatore monocomando bordo vasca con deviatore, bocca con effetto multigetto e doccetta in ottone cromato.

Single lever deck bath/shower mixer with diverter, spout with multijets effect and c.p. brass hand shower.



Incassi

Tramite la scelta di questi incassi doccia, con o senza deviazioni, quindi da una via a 5 vie, potrai costruirti il tuo set doccia preferito (oltre a quelli già proposti come combinazioni suggerite) utilizzando gli articoli proposti nella sezione doccia: doccette da pag. 436, saliscendi da pag. 422, bracci doccia da pag. 462, soffioni doccia da pag. 458, getti a pag. 465-466, bocche di erogazione da pag. 394, colonne doccia da pag. 470, supporti doccia a pag. 454. Ricordati di combinarli con la presa acqua (a pag. 442 doccette e a pag. 484 per colonne) ed il flessibile doccia desiderato (a pag. 486).

Più elementi inserirete più il miscelatore dovrà comprendere la possibilità di deviare il flusso da un elemento all'altro, ad esclusione di soluzioni con il deviatore integrato, vedi deviatore integrato su colonne doccia, su braccio doccia, su bocca di erogazione, etc.

Il Vostro rivenditore saprà comunque consigliarvi al meglio.



Q 30

Miscelatore monocomando da incasso senza deviatore per doccia.

Built-in shower single lever mixer without diverter.



Q 09

Miscelatore monocomando da incasso con deviatore per vasca/doccia.

Built-in bath/shower single-lever mixer with diverter.



Q 92

Miscelatore monocomando per doccia, con deviatore a due posizioni (due uscite ed una entrata) su piastra unica.

Single-lever shower mixer with 2 positions diverter (2 outlets and 1 inlet) on single flange.



Q 93

Miscelatore monocomando per doccia con deviatore a tre vie (una entrata e tre uscite) su unica piastra.

Single lever built-in shower mixer with three ways diverter (1 inlet and 3 outlets) on single flange.

Q 93 7

Miscelatore monocomando per doccia con deviatore a tre vie e sette posizioni (una entrata, tre uscite e sette posizioni con cui selezionare uscite singole o miscelate tra loro) su unica piastra.

Scatti della maniglia-deviatore:

lo scatto 1 aziona l'acqua dell'uscita 1

lo scatto 2 aziona l'acqua dell'uscita 2

lo scatto 3 aziona l'acqua dell'uscita 3

lo scatto 4 aziona l'acqua dell'uscita 1

lo scatto 5 aziona l'acqua delle uscite 1 + 2

lo scatto 6 aziona l'acqua delle uscite 1 + 2 + 3

lo scatto 7 aziona l'acqua delle uscite 2 + 3

Single lever built-in shower mixer with three ways diverter with seven positions (1 inlet and 3 outlets and seven positions to select single or mixed outlets) on single flange.

Handle steps of the diverter :

1st step to run water from outlet 1

2nd step to run water from outlet 2

3rd step to run water from outlet 3

4th step to run water from outlet 1

5th step to run water from outlets 1 + 2

6th step to run water from outlets 1 + 2 + 3

7th step to run water from outlets 2 + 3



Q 94

Miscelatore monocomando per doccia, con deviatore a 4 posizioni (4 uscite ed 1 entrata) su piastra unica.

Single-lever shower mixer with 4 positions diverter (4 outlets and 1 inlet) on single flange.

Q 95

Miscelatore monocomando per doccia, con deviatore a 5 posizioni (5 uscite ed una entrata) su piastra singola.

Single-lever shower mixer with 5 positions diverter (5 outlets and 1 inlet) on single flange.



Q 94 C

Miscelatore monocomando per doccia, con deviatore a 4 posizioni (4 uscite ed una entrata) su doppia piastra, con possibilità di chiusura del flusso dal deviatore durante il cambio di posizione (col vantaggio di non azionare posizioni non desiderate e non dover toccare la maniglia che seleziona anche la temperatura).

Single-lever shower mixer with 4 positions diverter (4 outlets and 1 inlet) on double flange, with the possibility of closing the flow from the diverter during the position change (with the advantage of not starting the undesired positions and also not be forced to touch the handle that also selects the temperature).

Q 95 C

Miscelatore monocomando per doccia, con deviatore a 5 posizioni (5 uscite ed una entrata) su doppia piastra, con possibilità di chiusura del flusso dal deviatore durante il cambio di posizione (col vantaggio di non azionare posizioni non desiderate e non dover toccare la maniglia che seleziona anche la temperatura).

Single-lever shower mixer with 5 positions diverter (5 outlets and 1 inlet) on double flange, with the possibility of closing the flow from the diverter during the position change (with the advantage of not starting the undesired positions and also not be forced to touch the handle that also selects the temperature).

Docce Exposed Shower Mixers



Q 39
Miscelatore monocomando esterno per doccia, con doccia duplex.

Wall mounted single-lever shower mixer, with duplex shower.

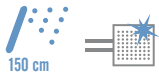

Q 31
Miscelatore monocomando esterno per doccia.

Wall mounted single-lever shower mixer.



Q 35
Gruppo doccia a muro, con attacco alto da 3/4" per colonna doccia.

Wall mounted shower mixer, with upper 3/4" connection pipe shower column.



317S 317SQ
Saliscendi quadro completamente in ottone con doccetta minimale SQ in abs cromato e flessibile conico in ottone cromato cm 150.

SQ sliding bar completely in c.p. brass, with handshower SQ in c.p. abs and one conical nut shower flexible cm 150.

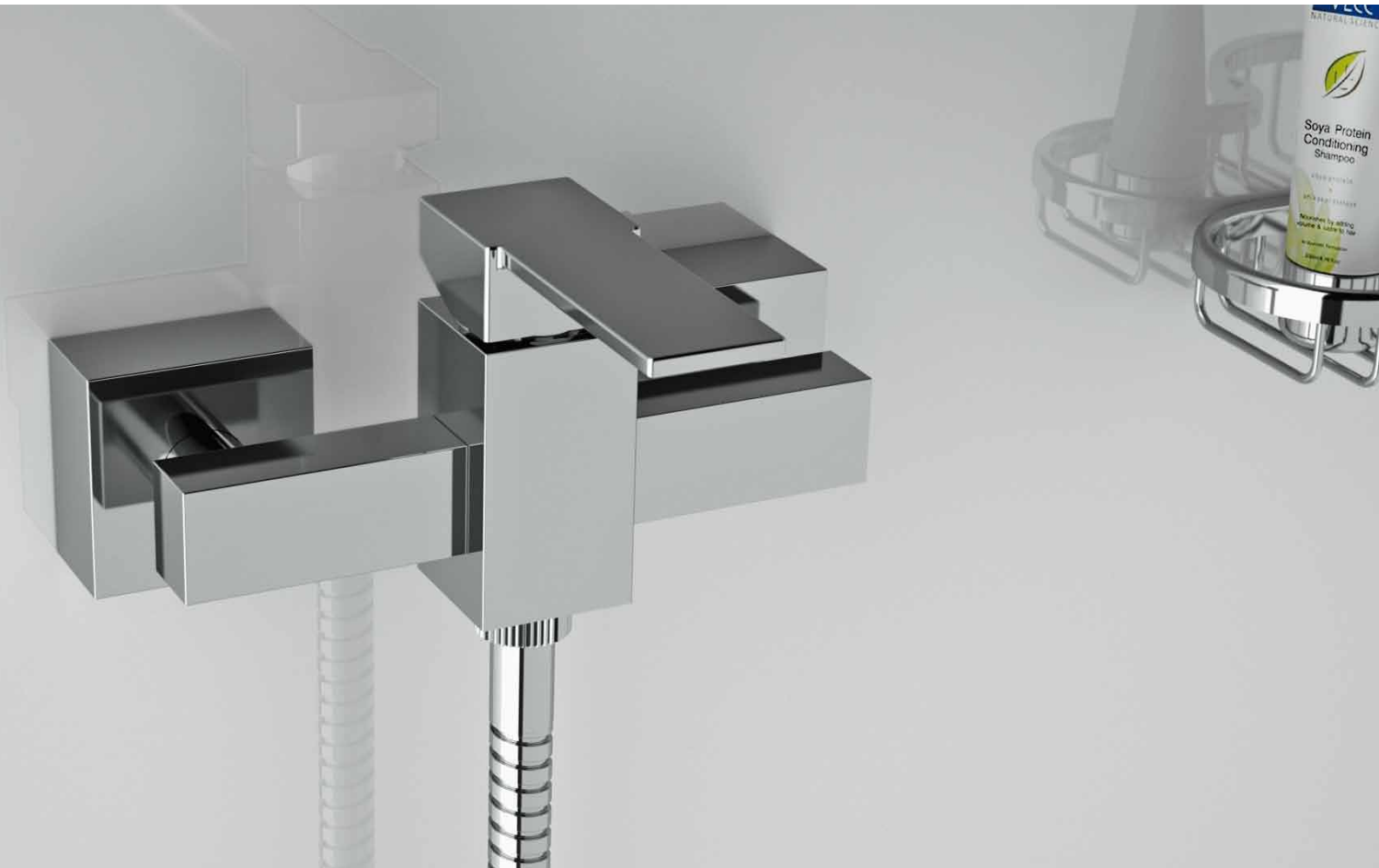

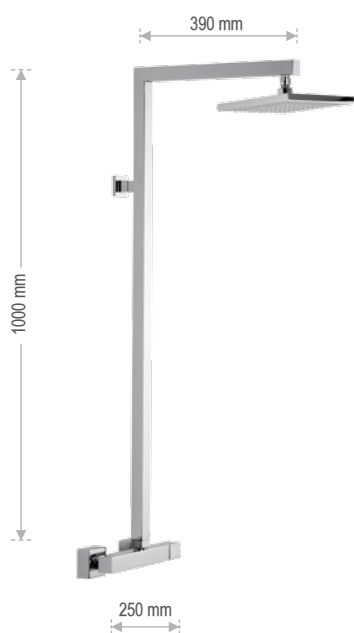

Q 36

Set doccia composto da:
Miscelatore esterno doccia Q35 con colonna doccia quadra con soffione completamente in ottone cromato e anticalcare 359SS 20x20 cm.

Shower set composed by:
External shower single lever mixer Q35 with squared shower column with showerhead all in c.p. brass art. 359SS 20x20 cm with silicone jets, anti-limestone.

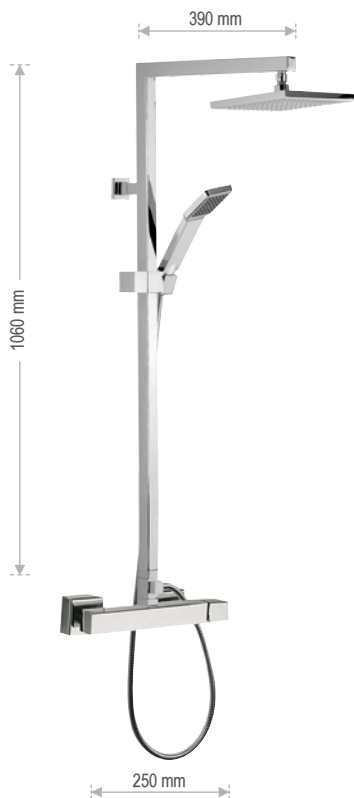

Q 37

Set doccia composto da:
Miscelatore esterno doccia Q35 con colonna doccia quadra con saliscendi e deviatore, doccetta 317 SQ in ABS e soffione completamente in ottone 359SS 20x20 cm. Flessibile in ottone cromato incluso.

Shower set composed by:
External shower single lever mixer serie Q35 with squared shower column with sliding central and diverter, including handshower 317 SQ in ABS and showerhead in c.p. brass 359SS 20x20 cm. Shower flexible in c.p. brass included.

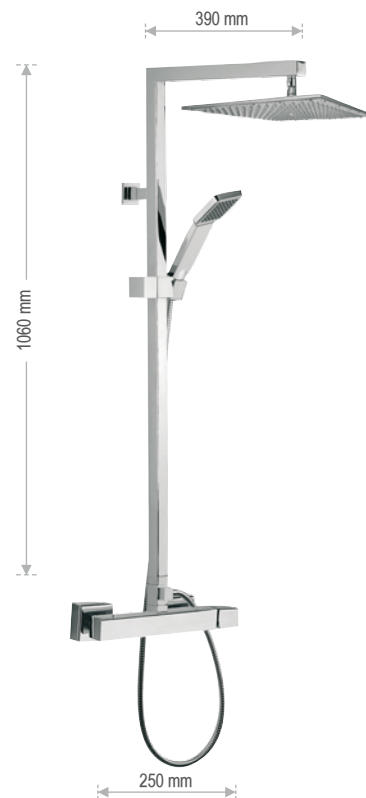
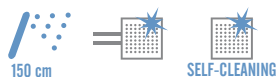

Q 37 XL

Set doccia composto da:
Miscelatore esterno doccia Q35 con colonna doccia quadra con saliscendi e deviatore, doccetta 317SQ in ABS e soffione completamente in ottone cromato 359SS XL 35x35 cm. Flessibile in ottone cromato incluso.

Shower set composed by:
External shower single lever mixer serie Q35 with squared shower column with sliding central and diverter, including handshower 317SQ in ABS and showerhead in c.p. brass 359 SSSL 35x35 cm. Shower flexible in c.p. brass included.

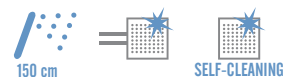

Wellness

Q 09 S01 UFS20

Set doccia composto da:

Art. 357UF20 348Q 30: Soffione doccia ultra piatto in acciaio INOX lucidato a specchio con braccio doccia Q in ottone cromato, cm 30.

Art. 317R 317RR: Saliscendi e doccetta tutto ottone serie ultrapiatta rettangolare minimale lusso con flessibile 333CN150 cm 150.

Art. 309 S: Presa acqua lusso quadrata.

Art. Q 09: Miscelatore incasso con deviatore.

Disponibile con soffione da cm 25x25, codice: Q 09 S01 UFS25

Disponibile con soffione da cm 30x30, codice: Q 09 S01 UFS30

Disponibile con soffione da cm 40x40 e braccio da 40 cm, codice: Q 09 S01 UFS40

Disponibile con braccio a soffitto con codice Q 09 S21 UFSS20

Shower set composed by:

Art. 357UF20 348Q 30: Ultra slim stainless steel mirror polished shower head with C.P. brass Q shower arm cm 30.

Art. 317R 317RR: Deluxe sliding rail and hand shower serie ultra flat rectangular minimal, all in c.p. brass with 333CN150 flexible hose cm 150.

Art. 309 S: Lux water punch SQ type.

Art. Q 09: Built-in mixer with diverter.

Available with head shower cm 25x25, code: Q 09 S01 UFS25

Available with head shower cm 30x30, code: Q 09 S01 UFS30

Available with head shower cm 40x40 and arm 40 cm, code: Q 09 S01 UFS40

Available with ceiling arm with code Q 09 S21 UFS20



150 cm



Q 09 S02 UFS20

Set doccia composto da:

Art. 357UF20 348Q 30: Soffione doccia ultra piatto in acciaio INOX lucidato a specchio con Braccio doccia Q in ottone cromato, cm 30.

Art. 337S: Supporto doccia deluxe duplex con presa acqua.

Art. 317RR con 333CN150 con doccetta ultrapiatta e flessibile conico in ottone cromato cm 150.

Art. Q 09: Miscelatore incasso con deviatore.

Disponibile con soffione da cm 25x25, codice: Q 09 S02 UFS25

Disponibile con soffione da cm 30x30, codice: Q 09 S02 UFS30

Disponibile con soffione da cm 40x40 e braccio da 40 cm, codice: Q 09 S02 UFS40

Disponibile con braccio a soffitto con codice Q 09 S22 UFSS20

Shower set composed by:

Art. 357UF20 348Q 30: Ultra slim stainless steel mirror polished shower head with C.P. brass Q shower arm cm 30.

Art. 337S: Duplex deluxe shower holder with water punch in c.p. brass.

Art. 317RR with 333CN150 ultraflat handshower with shower flexible hose in brass cm 150.

Art. Q 09: Built-in mixer with diverter.

Available with head shower cm 25x25, code: Q 09 S02 UFS25

Available with head shower cm 30x30, code: Q 09 S02 UFS30

Available with head shower cm 40x40 and arm 40 cm, code: Q 09 S02 UFS40

Available with ceiling arm with code Q 09 S22 UFS20



150 cm



Q937 S01 UFS20

Set doccia composto da:

Art. 357UF20 348Q 30: Soffione doccia ultra piatto in acciaio INOX lucidato a specchio con Braccio doccia Q in ottone cromato, cm 30.

Art. 317R 317RR: Saliscendi e doccetta tutto ottone serie ultrapiatta rettangolare minimale lusso con flessibile 333CN150 cm 150.

Art. 309 S: Presa acqua lusso quadrata.

Art. Q 93 7: Miscelatore incasso con deviatore a tre vie e sette posizioni su piastra unica.

Art. Q 34 JET: 6 getti anticalcare Q in ottone cromato.

Disponibile con soffione da cm 25x25, codice: Q937 S01 UFS25

Disponibile con soffione da cm 30x30, codice: Q937 S01 UFS30

Disponibile con soffione da cm 40x40 e braccio da 40 cm, codice: Q937 S01 UFS40

Disponibile con braccio a soffitto con codice Q937 S21 UFSS20

Shower set composed by:

Art. 357UF20 348Q 30: Ultra slim stainless steel mirror polished shower head with C.P. brass Q shower arm cm 30.

Art. 317R 317RR: Deluxe sliding rail and hand shower serie ultra flat rectangular minimal, all in c.p. brass with 333CN150 flexible hose cm 150.

Art. 309 S: Lux water punch SQ type.

Art. Q 93 7: Built-in mixer with three ways diverter with seven positions on single flange

Art. Q 34 JET: 6 jets anti-limestone in c.p. brass.

Available with head shower cm 25x25, code: Q937 S01 UFS25

Available with head shower cm 30x30, code: Q937 S01 UFS30

Available with head shower cm 40x40 and arm 40 cm, code: Q937 S01 UFS40

Available with ceiling arm with code: Q937 S21 UFS20



150 cm



Q937 S02 UFS20

Set doccia composto da:

Art. 357UF20 348Q 30: Soffione doccia ultra piatto in acciaio INOX lucidato a specchio con Braccio doccia Q in ottone cromato, cm 30.

Art. 337S: Supporto doccia deluxe duplex con presa acqua.

Art. 317RR con 333CN150 con doccetta ultrapiatta e flessibile conico in ottone cromato cm 150.

Art. Q 93 7: Miscelatore incasso con deviatore a tre vie e sette posizioni su piastra unica.

Art. Q 34 JET: 6 getti anticalcare Q in ottone cromato.

Disponibile con soffione da cm 25x25, codice: Q937 S02 UFS25

Disponibile con soffione da cm 30x30, codice: Q937 S02 UFS30

Disponibile con soffione da cm 40x40 e braccio da 40 cm, codice: Q937 S02 UFS40

Disponibile con braccio a soffitto con codice Q937 S22 UFSS20

Shower set composed by:

Art. 357UF20 348Q 30: Ultra slim stainless steel mirror polished shower head with C.P. brass Q shower arm cm 30.

Art. 337S: Duplex deluxe shower holder with water punch in c.p. brass.

Art. 317RR with 333CN150 ultraflat handshower with shower flexible hose in brass cm 150.

Art. Q 93 7: Built-in mixer with three ways diverter with seven positions on single flange

Art. Q 34 JET: 6 jets anti-limestone in c.p. brass.

Available with head shower cm 25x25, code: Q937 S02 UFS25

Available with head shower cm 30x30, code: Q937 S02 UFS30

Available with head shower cm 40x40 and arm 40 cm, code: Q937 S02 UFS40

Available with ceiling arm with code: Q937 S22 UFS20



150 cm





Q 937 S01 SSCA

Set doccia composto da:

Art. 350 SS CA: Soffione doccia a parete in acciaio INOX lucidato a specchio, 2 getti, normale o cascata.

Art. 317R 317RR: Saliscendi e doccetta tutto ottone serie ultrapiatta rettangolare minimale lusso con flessibile 333CN150 cm 150.

Art. 309 S: Presa acqua lusso quadrata.

Art. Q 93 7: Miscelatore monocomando per doccia con deviatore a tre vie e 7 uscite su piastra unica.

Disponibile con soffione 350 SS senza cascata, e miscelatore incasso con deviatore Q09, codice: Q09 S01 SS

Shower set composed by:

Art. 350 SS CA: Stainless steel mirror polished wall shower head, 2 jets, normal and waterfall.

Art. 317R 317RR: Deluxe sliding rail and hand shower serie ultra flat rectangular minimal, all in c.p. brass with 333CN150 flexible hose cm 150.

Art. 309 S: Lux water punch SQ type.

Art. Q 93 7: Single lever built-in shower mixer with three ways and 7 positions diverter on single flange.

Available with head shower 350 SS without waterfall jet and built-in mixer with diverter Q09, code: Q09 S01 SS



150 cm



Q 937 S02 SSCA

Set doccia composto da:

Art. 350 SS CA: Soffione doccia a parete in acciaio INOX lucidato a specchio, 2 getti, normale o cascata.

Art. 337S: Supporto doccia deluxe duplex con presa acqua.

Art. 317RR con 333CN150 con doccetta ultrapiatta e flessibile conico in ottone cromato cm 150.

Art. Q 93 7: Miscelatore monocomando per doccia con deviatore a tre vie e 7 uscite su piastra unica.

Disponibile con soffione 350 SS senza cascata, e miscelatore incasso con deviatore Q09, codice: Q09 S02 SS

Shower set composed by:

Art. 350 SS CA: Stainless steel mirror polished wall shower head, 2 jets, normal and waterfall.

Art. 337S: Duplex deluxe shower holder with water punch in c.p. brass.

Art. 317RR with 333CN150 ultraflat handshower with shower flexible hose in brass cm 150.

Art. Q 93 7: Single lever built-in shower mixer with three ways and 7 positions diverter on single flange.

Available with head shower 350 SS without waterfall jet and built-in mixer with diverter Q09, code: Q09 S02 SS



150 cm



Q 94 S01 SSCA

Set doccia composto da:

Art. 350 SS CA: Soffione doccia a parete in acciaio INOX lucidato a specchio, 2 getti, normale o cascata.

Art. 317R 317RR: Saliscendi e doccetta tutto ottone serie ultrapiatta rettangolare minimale lusso con flessibile 333CN150 cm 150.

Art. 309 S: Presa acqua lusso quadrata.

Art. Q 93 7: Miscelatore monocomando per doccia con deviatore a tre vie e sette posizioni su piastra unica.

Art. Q 34 JET: 6 getti anticalcare Q in ottone cromato.

Disponibile con soffione 350 SS senza cascata, codice: Q 937 S01 SS

Shower set composed by:

Art. 350 SS CA: Stainless steel mirror polished wall shower head, 2 jets, normal and waterfall.

Art. 317R 317RR: Deluxe sliding rail and hand shower serie ultra flat rectangular minimal, all in c.p. brass with 333CN150 flexible hose cm 150.

Art. 309 S: Lux water punch SQ type.

Art. Q 93 7: Single lever built-in shower mixer with three ways diverter with seven positions on single flange.

Art. Q 34 JET: 6 jets anti-limestone in c.p. brass.

Available with head shower 350 SS without waterfall jet, code: Q 937 S01 SS



150 cm



Q 94 S02 SSCA

Set doccia composto da:

Art. 350 SS CA: Soffione doccia a parete in acciaio INOX lucidato a specchio, 2 getti, normale o cascata.

Art. 337S: Supporto doccia deluxe duplex con presa acqua.

Art. 317RR con 333CN150 con doccetta ultrapiatta e flessibile conico in ottone cromato cm 150.

Art. Q 93 7: Miscelatore monocomando per doccia con deviatore a tre vie e sette posizioni su piastra unica.

Art. Q 34 JET: 6 getti anticalcare Q in ottone cromato.

Disponibile con soffione 350 SS senza cascata, codice: Q 937 S02 SS

Shower set composed by:

Art. 350 SS CA: Stainless steel mirror polished wall shower head, 2 jets, normal and waterfall.

Art. 337S: Duplex deluxe shower holder with water punch in c.p. brass.

Art. 317RR with 333CN150 ultraflat handshower with shower flexible hose in brass cm 150.

Art. Q 93 7: Single lever built-in shower mixer with three ways diverter with seven positions on single flange.

Art. Q 34 JET: 6 jets anti-limestone in c.p. brass.

Available with head shower 350 SS without waterfall jet, code: Q 937 S02 SS



150 cm

Wellness



Q 09 S01

Set doccia composto da:

Art. 359SS 348S 30: Soffione SQ in ottone anticalcare con braccio quadro in ottone cm 30.

Art. 317S 317SQ: Saliscendi quadro con doccetta Q anticalcare e flessibile conico in ottone cromato cm 150.

Art. Q 09: Miscelatore incasso con deviatore.

Disponibile con braccio a soffitto con codice Q 09 S21

Shower set composed by:

Art. 359SS 348S 30: SQ showerhead in c.p. brass anti-limestone with squared arm in brass cm 30.

Art. 317S 317RR: SQ sliding bar with Q anti-limestone handshower with shower flexible hose in brass cm 150.

Art. 309 S: Lux water punch SQ type.

Art. Q 09: Built-in mixer with diverter.

Available with ceiling arm with code Q 09 S21

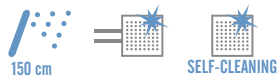

Q 09 S02

Set doccia composto da:

Art. 359SS 348S30: Soffione SQ in ottone anticalcare con braccio quadro in ottone cm 30.

Art. 337S: Supporto doccia deluxe duplex con presa acqua.

Art. 317SQ con 333CN150 con doccetta Q anticalcare e flessibile conico in ottone cromato cm 150.

Art. Q 09: Miscelatore incasso con deviatore.

Disponibile con braccio a soffitto con il codice Q 09 S22

Shower set composed by:

Art. 359SS 348S30: SQ showerhead in c.p. brass anti-limestone with squared arm in brass cm 30.

Art. 337S: Duplex deluxe shower holder with water punch in c.p. brass.

Art. 317SQ with 333CN150 anti-limestone Q handshower with shower flexible hose in brass cm 150.

Art. Q 09: Built-in mixer with diverter.

Available with ceiling arm with code Q 09 S22



Q 09 S03

Set doccia composto da:

Art. 359SS 348S30: Soffione SQ in ottone anticalcare con braccio quadro in ottone cm 30.

Art. 339S 317SQ con 333CN 150: Supporto doccia cromato con doccetta Q anticalcare e flessibile conico in ottone cromato cm 150.

Art. 91 QD: Bocca incasso Q con deviatore.

Art. Q 09: Miscelatore incasso con deviatore.

Disponibile con braccio a soffitto con codice Q 09 S23

Shower set composed by:

Art. 359SS 348S30: SQ showerhead in c.p. brass anti-limestone with squared arm in brass cm 30.

Art. 339S 317SQ with 333CN150: c.p. shower holder with anti-limestone Q handshower with shower flexible hose in brass cm 150.

Art. 91QD: Built-in spout serie Q with diverter.

Art. Q 09: Built-in mixer with diverter.

Available with ceiling arm with code Q 09 S23



Q 93 7 S01

Set doccia composto da:

Art. 359SS 348S30: Soffione SQ in ottone anticalcare con braccio quadro in ottone cm 30.

Art. 317S 317SQ: saliscendi Q in ottone cromato con doccetta Q anticalcare e flessibile conico in ottone cromato cm 150

Art. 309S: Presa acqua Q in ottone cromato.

Art. Q 34 JET: 6 getti anticalcare Q in ottone cromato.

Art. Q 93 7: Miscelatore incasso con deviatore a tre vie e sette posizioni su piastra unica.

Disponibile con braccio a soffitto con il codice Q 93 7 S21

Shower set composed by:

Art. 359SS 348S30: SQ showerhead in c.p. brass anti-limestone with squared arm in brass cm 30.

Art. 317S 317SQ: Q sliding bar in c.p. brass and anti-limestone Q handshower with shower flexible hose in brass cm 150

Art. 309S: Deluxe Q water punch, in c.p. brass.

Art. Q 34 JET: 6 jets anti-limestone in c.p. brass.

Art. Q 93 7: Built-in mixer with three ways diverter with seven positions on single flange.

Available with ceiling arm with code Q 93 7 S21

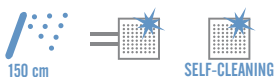

Q 93 7 S02

Set doccia composto da:

Art. 359SS 348S30: Soffione SQ in ottone anticalcare con braccio quadro in ottone cm 30.

Art. 337 S: Supporto doccia deluxe duplex con presa acqua.

Art. 317SQ con 333CN 150: con doccetta Q anticalcare e flessibile conico in ottone cromato cm 150.

Art. Q 34 JET: 6 getti anticalcare Q in ottone cromato.

Art. Q 93 7: Miscelatore incasso con deviatore a tre vie e sette posizioni su piastra unica.

Disponibile con braccio a soffitto con il codice Q 93 7 S22

Shower set composed by:

Art. 359SS 348S30: SQ showerhead in c.p. brass anti-limestone with squared arm in brass cm 30.

Art. 337S: Duplex deluxe shower holder with water punch in c.p. brass

Art. 317SQ with 333CN 150: anti-limestone Q handshower with shower flexible hose in brass cm 150.

Art. Q 34 JET: 6 jets anti-limestone in c.p. brass.

Art. Q 93 7: Built-in mixer with three ways diverter with seven positions on single flange.

Available with ceiling arm with code Q 93 7 S22

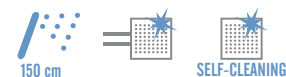



Q 30 S11

Set doccia composto da:
 Art. 330S 359 SS 317SQ 333CN 150: Colonna doccia a barra quadrata, deluxe, con deviatore e saliscendi, soffione doccia quadrato in ottone con getti in silicone anticalcare, doccetta serie Qubika anticalcare, flessibile doccia conico in ottone.
 Art. 330S RA: Presa acqua-attacco a muro quadrato.
 Art. Q 30: Miscelatore incasso doccia Qubika.

Shower set composed by:
 Art. 330S 359 SS 317SQ 333CN 150: Squared bar deluxe shower column, with diverter and sliding part, squared shower head in brass with silicone jets, anti-limestone, Qubika anti-limestone handshower, conical nut flexible hose in brass.
 Art. 330S RA: Squared water punch and wall connection.
 Art. Q30: Built-in single-lever shower mixer Qubika.

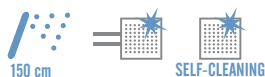

**Cucina
Kitchen**



Q 40
 Miscelatore monocomando per lavello, corpo quadrato.
 Single lever one-hole squared sink mixer.

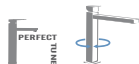

Q 42 U
 Miscelatore monocomando per lavello, con bocca alta a "U".
 Single-lever one-hole sink mixer, with high "U" spout.

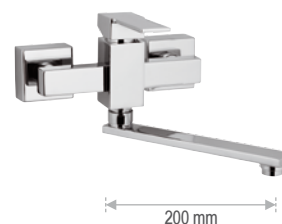

Q 41
 Miscelatore monocomando esterno per lavello a muro con bocca squadrata.
 Single-lever wall mounted sink mixer, with squared spout.



**Cucina Acqua Depurata
Purified Water Kitchen**



S 40 DW
 Miscelatore lavello Quadrato a tre vie di ingresso con bocca girevole, con selezione acqua potabile tramite la leva, con 2 aeratori in uscita.
 Three ways inlet squared single lever sink mixer, with movable spout, with selection for drinking water directly from the lever, with 2 exit aerators.



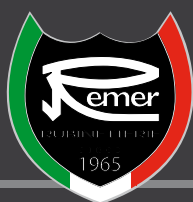

Remer Rubinerie S.p.A.
Via Leonardo da Vinci, 83
20062 Cassano d'Adda (MI) Italy
Tel. +39 0363 364 211
E-Mail: info@remer.eu
www.remer.eu

Ufficio Commerciale Italia:
Tel. 0363 364 333
Fax 0363 63 575

Export Commercial Department:
Tel. +39 0363 364 364
Fax +39 0363 364 300